

# LED LIGHTING TECHNOLOGY

## Introduction

From LED's earliest years, Crystal Fountains has been at the forefront of exploring LED lighting technology for water features. LED lighting is an exciting new way of thinking about and installing a lighting system. At the heart of each LED (Light Emitting Diode) is a microprocessor that emits light when an electric current passes through it. Can be programmed individually, digital light shows can switch with incredible speed, variation and accuracy. With RGB color (Red, Green, Blue) you have a virtually unlimited palette of color to work with!

Other advantages of LED lighting:

- Lower power requirements
- High Efficiency/Produces Less Heat
- Long life/Saves Maintenance Time and Costs
- Limitless Design Flexibility with Color Intensity/Variety
- Can individually control each LED lamp for limitless color sequencing potential

LED lighting technology requires a systems approach. Crystal Fountains can supply all the components you require and assist you with product selection, sequenced show programming or technical support. LED Lighting works as an integrated total networked lighting system and includes 3 elements:

- LED Light Fixture and/or Nozzle
- Animation Panel with Power/Data supply keypad
- Power/Data cable

140	LED LIGHTING TECHNOLOGY
141	Types of LED Lights
142	LED002 Series – Compact LED Light
144	LED007 Series – Ultra Compact LED Light
145	LED020 Series – 120VAC/60W Low Profile White Underwater LED Light
147	LED052 Series – 12V/30W LED Color Changing Light
149	LED053 Series – 24VDC/30W LED Color Changing Light
151	LED054 Series – 24VDC/30W LED White Light - Wet and Dry
153	LED055 Series – 12VDC/18W LED White Light
155	LED060 Series – 24VDC/60W LED Color Changing and White Light - Wet and Dry
157	LED160 Series – 12V/30W RGB or White LED Ring Light
160	LED190 Series – 12V/30W Niche RGB or White LED Playdeck Light



## Types of LED Lights

**C**rystal Fountains manufactures a range of leading LED lighting products that can stand alone as lighting fixtures or have a combination of LED light and nozzle effect all in one unit. In this section we will show you our family of LED lights only.

**Not all LED lights are created equally! Crystal Fountains manufactures a range of the brightest LED lighting products manufactured with perfect optical performance. We offer LED lighting:**

- Safe 12VAC/DC and 24VDC
- Longer cable lengths between light and controller for easier installation
- Super compact to heavy duty with multiple mounting
- White to RGB color-changing - fully addressable
- For fountains or playdecks



Basic LED System (LED Light, Choreoswitch, Power & Data Supply, Control Panel)

## LED002 Series – Compact LED Light - Wet and Dry

This attractive, compact LED light is available with either a warm or cool white LED or full RGB color LED. Its compact size allows close placement to any jet for maximum light usage or in tight surroundings. RGB provides limitless color sequencing potential. Light allows for gentle lighting of low effects and waterwalls as well as very good projection for high vertical nozzle effects. RGB (LEDEQMRF AND LEDEQMRS) lamps are fully programmable to suit your design needs and work in a systems approach with the LEDPS70 power supply and LEDQUE1 – I-player/DMX controller. Pre-programmed RGB lamps (EQS021A100) are also available that come standard with 24 programs and can work with optional handheld remote controller (EL RGBC 5W). Remote control can work with an unlimited number of lights to dim and change colors of individual lights. Available in different cable lengths and with many mounting configurations to suit your lighting needs from freestanding to niche mounted. Submersible IP68, CE Marking, cULus listed. Made of 316 stainless steel.

**Not all LEDs are created equally! Crystal Fountains LED products produce a high intensity light and deliver perfect optical performance. Also, see Crystal Fountains power/data and controller products to create a complete LED system.**

*\*Contact Crystal Fountains for detailed specifications, installation and operation details.*

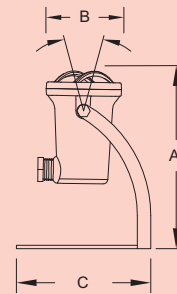

### DIMENSIONS

Part No.	a dim. (mm)	b dim. (mm)	c dim. (mm)
LED002002	166	70	127

### CHOOSE LAMP

Color	Type	Lamp	Part No.
RGB	5W24VDC	Flood	LEDQMRF
	5W24VDC	Spot	LEDQMRS
	5W12VDC	Spot	EQS021A100*
Warm White	3W12V (AC/DC)	Flood	EL002A102
	3W12V (AC/DC)	Spot	EL002A101
Cool White	3W12V (AC/DC)	Flood	EL002A104
	3W12V (AC/DC)	Spot	EL002A103

\*EQS021A100 lamp is not UL listed

## How to Order

### CHOOSE LIGHT

Mounting	Part No.
Stand	LED002002

### CHOOSE CABLE

Cable Length	Part No.
3 m.	ELCORD005M03
6 m.	ELCORD005M06

### CHOOSE ADDITIONAL OPTIONS

Options	Part. No.
Remote Control	EL RGBC 5W



# LED002 Series – Compact LED Light - Wet and Dry

CANDLE POWER DISTRIBUTION FOR LEDEQMRS

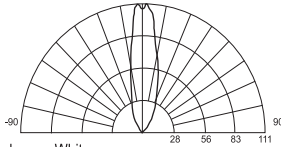

Measured on: White  
 Beam Center: 106cd  
 Multipliers: 0.34 Red, 0.47 Green, 0.21 Blue

CANDLE POWER DISTRIBUTION FOR LEDEQMRM

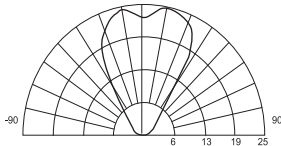

Measured on: White  
 Beam Center: 25cd  
 Multipliers: 0.4 Red, 0.18 Green, 0.42 Blue

ILLUMINANCE DISTRIBUTION 5W/24WATT LEDEQMRS LAMP

0.3	1.3	1.4	2.3	1.3	0.3	1.5'/0.5m
3.2	14.0	15.1	24.8	14.0	3.2	
1.3	3.2	5.2	5.2	3.2	1.3	
14.0	34.4	56.0	56.0	34.4	14.0	
2.3	5.2	9.1	8.1	5.3	2.3	0'/0m
24.8	56.0	98.0	87.2	57.0	24.8	
1.4	5.3	8.2	9.1	5.3	1.4	
15.1	57.0	88.3	98.0	57.0	15.1	
1.3	3.3	5.4	5.4	3.3	1.3	
14.0	35.5	58.1	58.1	35.5	14.0	
0.3	1.3	1.4	2.4	1.3	0.3	1.5'/0.5m
3.2	14.0	15.1	25.8	14.0	3.2	
1.5'/0.5m		0'/0m			1.5'/0.5m	

ILLUMINANCE DISTRIBUTION 5W/24WATT LEDEQMRM LAMP

0.4	0.5	0.7	0.9	0.6	0.4	1.0'/0.3m
4.3	5.4	7.5	9.7	6.5	4.3	
0.6	1.0	1.2	1.1	0.9	0.6	
6.5	10.8	12.9	11.8	9.7	6.5	
0.9	1.2	1.7	1.6	1.1	0.9	0'/0m
9.7	12.9	18.3	17.2	11.8	9.7	
0.7	1.1	1.6	1.7	1.2	0.7	
7.5	11.8	17.2	18.3	12.9	7.5	
0.5	0.9	1.1	1.2	1.0	0.5	
5.4	9.7	11.8	12.9	10.8	5.4	
0.4	0.5	0.7	0.9	0.6	0.4	1.0'/0.3m
4.3	5.4	7.5	9.7	6.5	4.3	
1.0'/0.3m		0'/0m			1.0'/0.3m	

Units: Footcandles/Lux  
 Measured on: All, reflectance 0  
 Distance from surface: 1'/0.3m (from bottom of grid with light at perpendicular to surface)



## LED007 – Ultra Compact 5 watt LED Light - 12V

The LED007 is designed for situations where visibility of the light fixture needs to be de-emphasized and space near the nozzle is tight. The most compact 5 watt light on the market. Currently designed for suspended decks but can be used in multiple applications. Comes with spot light. Made of stainless steel and plastic.

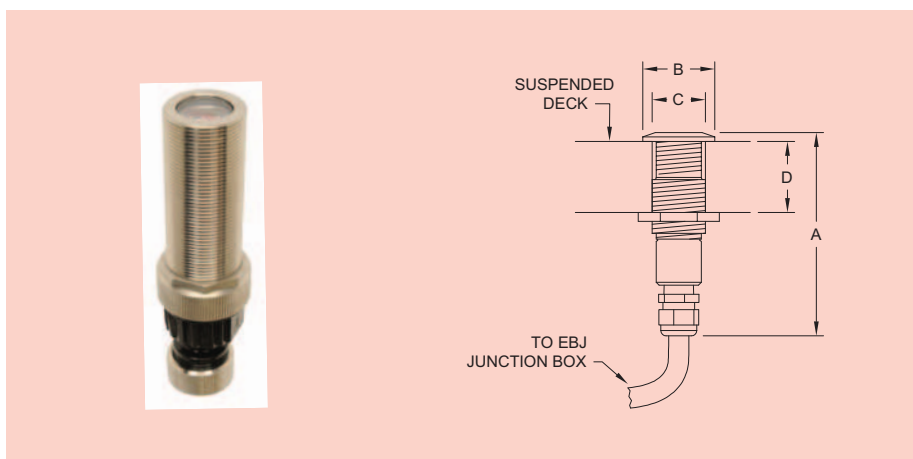
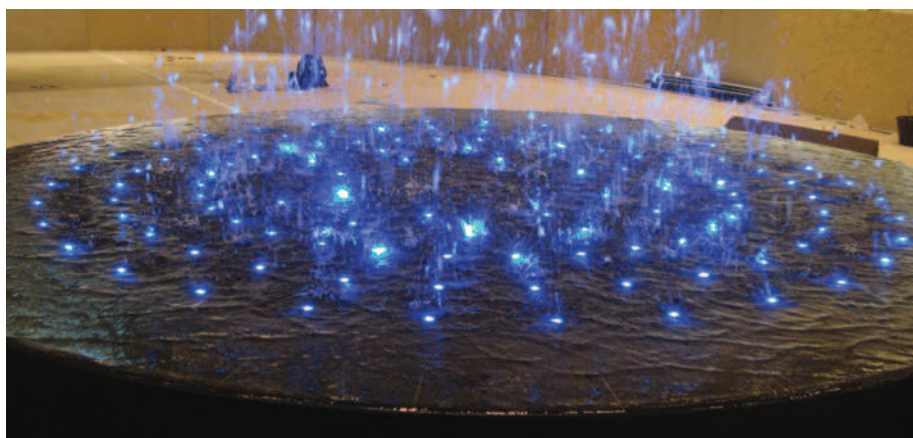

### DIMENSIONS

Part No.	a dim.	b dim.	c dim.	d dim.
LED007	127	51	39	51
LED008	127	51	39	51

## How to Order

### CHOOSE LIGHT

Lighting	Mounting	Lamp	Part No.
RGB	Light with Slab Hanger	Spot	LED007
White	Light with Slab Hanger	Spot	LED008

### CHOOSE CABLE

Cable for...	Cable Length	Part No.
RGB or White (Dimmable) Light	3 m.	EL CORD007M03
	6 m.	EL CORD007M06
White (Non-Dimmable) Light	3 m.	EL CORD007MW03
	6 m.	EL CORD007MW06

## LED020 Series – 120VAC/60W Low Profile White Underwater LED

### Light

The LED020 is a versatile LED underwater light ideal for lighting heavy water in fountains. Best operated at a minimum 51mm underwater, this white 120V LED light provides a low profile and substantial uplighting. Available in different cable lengths, lenses and with many mounting configurations to suit your lighting needs from free-standing to deep niche mounted. Also available with optional lens guard. cETLus and IP68 listed. Made of cast bronze.

**Not all LEDs are created equally! Crystal Fountains LED products produce a high intensity light and deliver perfect optical performance.**

*\*Contact Crystal Fountains for detailed specifications, installation and operation details.*



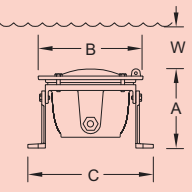

LEDB020 -  
Light with T-Foot

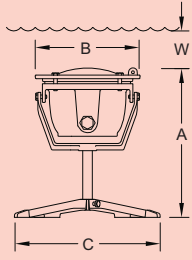
LEDC020 -  
Freestanding Light

LEDD020 -  
Light with Niche

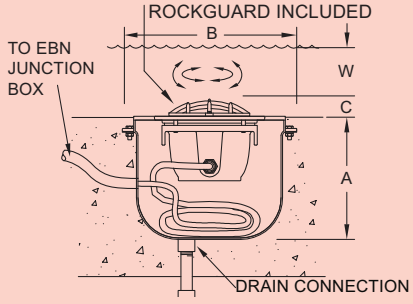
LEDS020 -  
Light with Slab Hanger

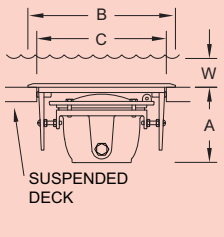

# LED020 Series – 120VAC/60W Low Profile White Underwater LED Light

LED LIGHTING TECHNOLOGY



## DIMENSIONS

Part No.	a dim. (mm)	b dim. (mm)	c dim. (mm)	w dim. (mm)
LEDB020	159	185	223	51
LEDC020	185 or 407	185	254	51
LEDD020	204	293	51	51
LEDS020	140	261	223	51

## How to Order

### CHOOSE LIGHT

Light Fixture	Part No.
<b>Series</b>	<b>Options</b>
LEDB	n/a
	rockguard
LEDC	195 mm. high
	400 mm. high
	195 mm. w/. rockguard
	400 mm. w/. rockguard
LEDD	n/a
	drain conn.
LEDS	n/a

### CHOOSE CABLE

Cable Length	Thermal Cut-Off	Part No.
3 m.	No	EL CORD 020A109
	Yes	EL CORD 020T109
6 m.	No	EL CORD 020A120
	Yes	EL CORD 020T120
9 m.	No	EL CORD 020A130
	Yes	EL CORD 020T130
12 m.	No	EL CORD 020A140
	Yes	EL CORD 020T140
Over 12 m.	Yes/No	Contact Factory

### EXAMPLE OF HOW TO ORDER

Quantity	Product	Part No.
1	407 mm. Freestanding light with rockguard	LEDC020LP
1	3 m. Cable	ELCORD 020A109

Note: Photometric Chart is available upon request.

## LED052 Series – 12V/30W LED Color Changing Light - Wet and Dry

General purpose 12VDC underwater, wet and dry location light fixture with RGB color-changing technology. Lots of flexibility to suit your application - available in 4 different mounting styles from freestanding to niche mounted. Also available in 2 different cable lengths and spot or flood lamp. Best used to light no higher than 6m. Works in a systems approach with many generic power supplies and DMX controllers\*. (See LED Accessories on pg 161). CE Marking and cULus listed to safety standards for use in traditional basin style fountains. (Not for swimming pool and spas). Cable to be ordered separately and pre-installed. Made of cast bronze, copper with stainless steel fasteners.

**Not all LEDs are created equally! Crystal Fountains LED products produce a high intensity light and deliver perfect optical performance. Also, see Crystal Fountains power/data and controller products to create a complete LED system.**

*\*Contact Crystal Fountains for detailed specifications, installation and operation details.*

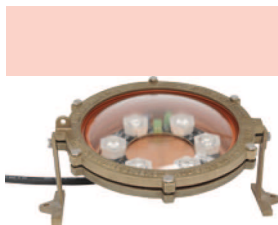
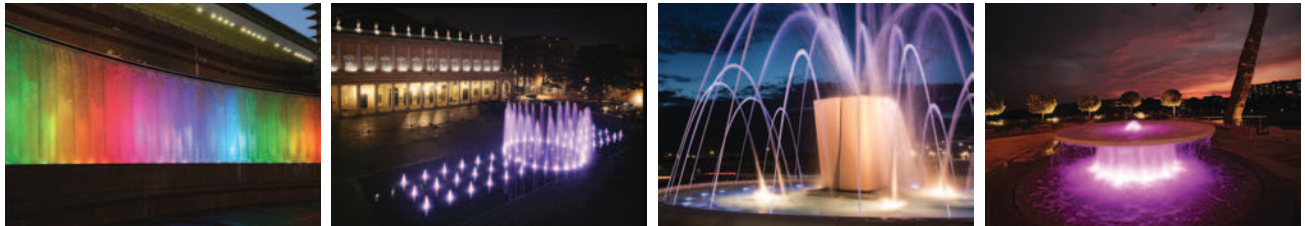

HINGED LENS GUARD (OPTIONAL)

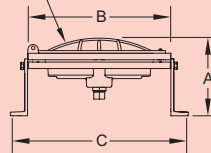

LEDB052 - Light with T-Foot

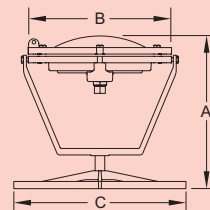
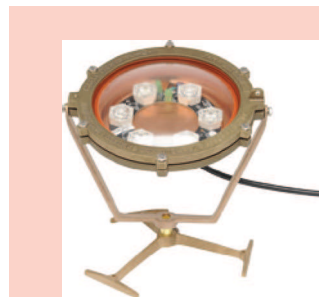

LEDC052 - Freestanding Light

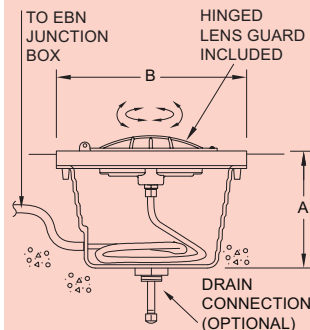

LEDD052 - Light with Niche

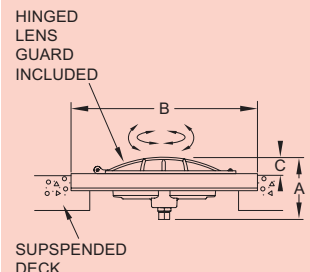
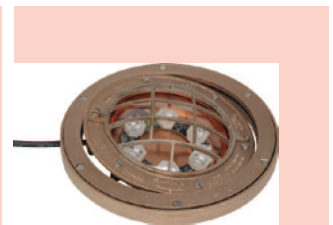

LEDS052 - Light with Slab Hanger

### DIMENSIONS

Part No.	a dim. (mm)	b dim. (mm)	c dim. (mm)
LEDB052	127	261	
LEDC052	280 to 407	280	248
LEDD052	229	331	
LEDS052	115	331	26



# LED052 Series – 12V/30W LED Color Changing Light - Wet and Dry

## How to Order

### CHOOSE CABLE

Cable Length	Part No.
3 m.	ELCORD050M03
6 m.	ELCORD050M06

### CHOOSE ADDITIONAL OPTIONS

OPTIONS	PART NUMBER
Flood Optics	contact Crystal for details
Remote Control	EL RGBC 5W

### CHOOSE LIGHT

Light Fixture		Part No.
Series	Options	
LEDB	n/a	LEDB052
	rockguard	LEDB052P
LEDC	280 mm. high	LEDC052
	407 mm. high	LEDC052L
	280 mm. w/. rockguard	LEDC052P
	407 mm. w/. rockguard	LEDC052LP
LEDD	n/a	LEDD052
LEDS	n/a	LEDS052

### EXAMPLE OF HOW TO ORDER

Quantity	Product	Part No.
1	Light with T-Foot	LEDB052
1	6 m. Cable	ELCORD050M06
6	Flood Optics	LED160C006F

RGB LED Light

Photometry Test is done in accordance with IES no. LM-35-1989

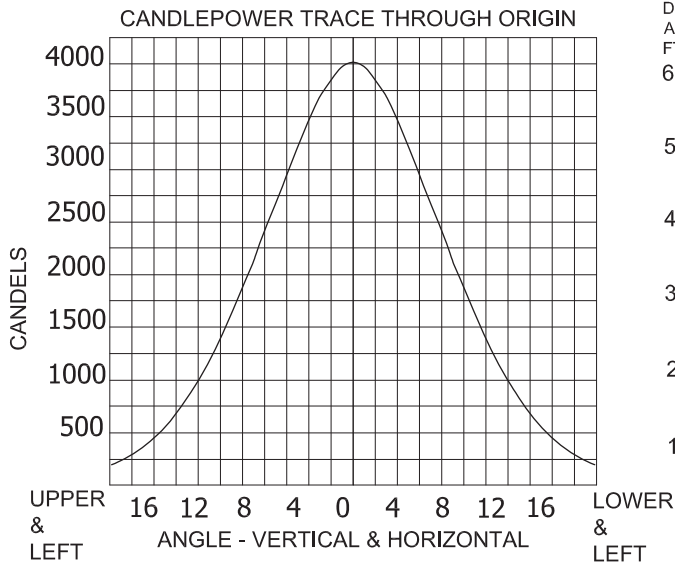

**ILLUMINANCE DISTRIBUTION (FC/LUX)**

DISTANCE ABOVE FT/M	0'/0m	1'/0.33m	2'/0.67m	3'/1.0m
6'/2.00m	112	43.8	5.0	1.2
	1012	392	45.3	10.5
5'/1.67m	162	43.7	3.2	1.3
	1453	392	28.9	12.0
4'/1.33m	253	36.0	2.6	1.2
	2293	320	23.7	10.4
3'/1.00m	451	20.1	3.1	2.3.6
	4061	179	27.5	5.3
2'/0.67m	1020	10.6	1.3	0.3
	9072	94.5	11.9	2.7
1'/0.33m	4122	5.2	0.4	0.1
	37711	46.1	3.3	0.8

DISTANCE FROM CENTER (FT/M)

# LED053 Series – 24VDC / 30 W LED Color Changing Light - Wet and Dry

A general purpose 24VDC underwater, wet and dry location light fixture with RGB color changing technology. Lots of flexibility to meet your application – available in 4 different mounting styles from free standing to niche mounted. Also available in 2 different cable lengths and spot or flood lamp. Best used to light no higher than 6 m. Works in a systems approach with many generic power supplies and DMX controllers\*. (See LED Accessories on pg 161). CE Marking and cULus listed to safety standards for use in traditional basin style fountains. (Not for swimming pool and spas). Made of cast bronze, copper with stainless steel.

Not all LED products are created equally. Crystal Fountains LED products produce a high intensity light and deliver perfect optical performance. Also see Crystal Fountains power/data and controller products to create a complete LED system.



HINGED LENS GUARD (OPTIONAL)

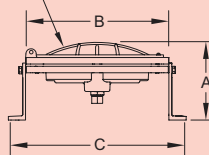

LEDB053 - Light with T-Foot

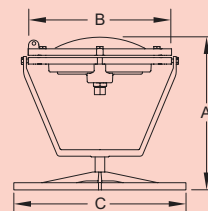

LEDC053 - Freestanding Light

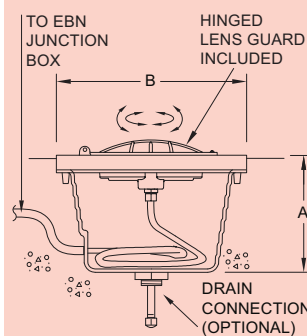

LEDD053 - Light with Niche

HINGED LENS GUARD INCLUDED

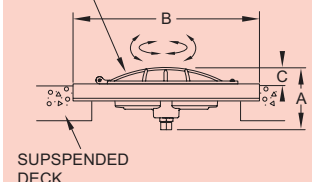

LEDS053 - Light with Slab Hanger

## DIMENSIONS

Part No.	a dim. (mm)	b dim. (mm)	c dim. (mm)
LEDB053	127	261	
LEDC053	280 to 407	280	248
LEDD053	229	331	
LEDS053	115	331	26

# LED053 Series – 24VDC / 30 W LED Color Changing Light – Wet and Dry

## How to Order

### CHOOSE CABLE

Cable Length	Part No.
3 m.	EL CORD160M03
6 m.	EL CORD160M06

### CHOOSE ADDITIONAL OPTIONS

OPTIONS	PART NUMBER
Flood Optics	contact Crystal for details

### CHOOSE LIGHT

Light Fixture	Part No.
Series Options	
LEDB n/a	LEDB053
rockguard	LEDB053P
LEDC 280 mm. high	LEDC053
407 mm. high	LEDC053L
280 mm. w/ rockguard	LEDC053P
407 mm. w/ rockguard	LEDC053LP
LEDD n/a	LEDD053
drain	LEDD053D
LEDS n/a	LEDS053

### EXAMPLE OF HOW TO ORDER

Quantity	Product	Part Number
1	Niched Light with Drain	LEDD053D
1	3 m. Cable	EL CORD160M03

RGB LED Light

Photometry Test is done in accordance with IES no. LM-35-1989 & LM-79-08

CANDLEPOWER TRACE THROUGH ORIGIN

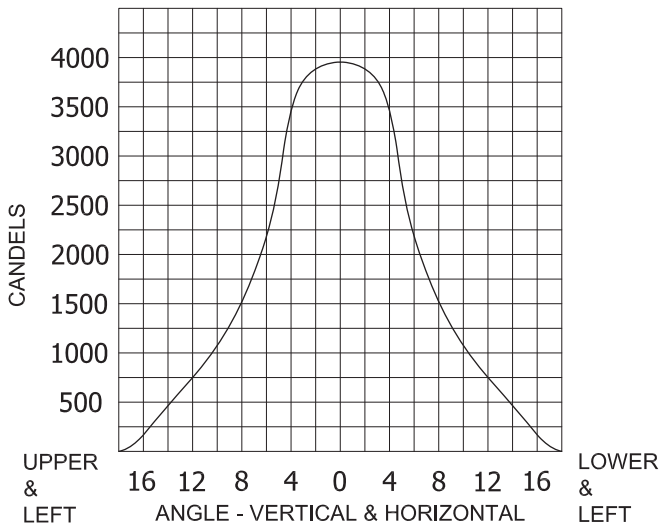

DISTANCE ABOVE FT/M	ILLUMINANCE DISTRIBUTION (FC/LUX)			
6'/2.00m	111 1000	45.8 410	4.1 36.7	1.1 9.9
5'/1.67m	160 1435	44.8 401	2.6 23.9	1.3 11.6
4'/1.33m	250 2265	32.5 289	2.5 22.4	1 9.3
3'/1.00m	446 4013	16.3 145	2.8 24.8	0.5 4.6
2'/0.67m	1008 8962	10 89	1.1 10.3	0.3 2.3
1'/0.33m	4073 37245	4.5 39.7	0.4 3.2	0.1 0.6
	0'/0m	1'/0.33m	2'/0.67m	3'/1.0m
	DISTANCE FROM CENTER (FT/M)			



## LED054 Series – 24VDC/30W LED White Light - Wet and Dry

General purpose 24VDC White LED light is perfect for underwater use including wall washing, wall washing, and wet/dry locations. 18 LED's mounted in a smart PCB board creates Available in 5 different mounting styles from free-standing to niche mounted. Also available in 4 different cable lengths and spot or flood lamp. A dimmable white light version is also available. Works in a systems approach with the power supply and I-player/DMX controller\*. CE Marking and c-UL-us listed to safety standards for use in traditional basin style fountains. (Not for swimming pool and spas). Cable, lamp and rock guard to be ordered separately and pre-installed. Made of cast bronze, copper with stainless steel fasteners.

**Not all LEDs are created equally! Crystal Fountains LED products produce a high intensity light and deliver perfect optical performance. Also, see Crystal Fountains power/data and controller products to create a complete LED system.**

*\*Contact Crystal Fountains for detailed specifications, installation and operation details.*

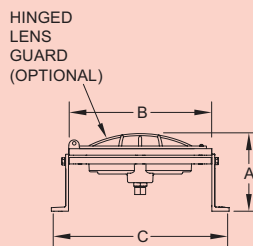
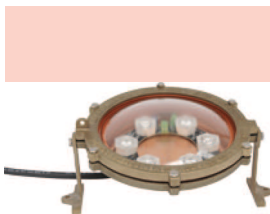

LEDB054 - Light with T-Foot

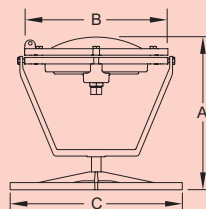

LEDC054 - Freestanding Light

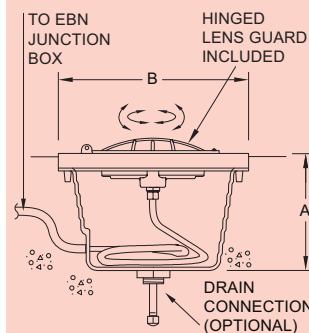

LEDD054 - Light with Niche

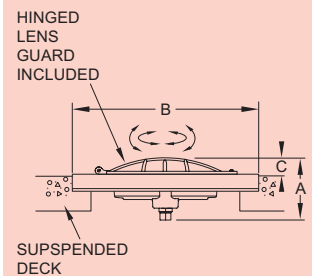

LEDS054 - Light with Slab Hanger

# LED054 Series – 24VDC/30W LED White Light - Wet and Dry

## DIMENSIONS

Part No.	a dim. (mm)	b dim. (mm)	c dim. (mm)
LEDB054	127	261	305
LEDC054	280 to 407	280	248
LEDD054	229	331	
LEDS054	115	331	26

## How to Order

### CHOOSE LIGHT

Light Fixture		Part No.
Series	Options	
LEDB	n/a	LEDB054
	rockguard	LEDB054P
LEDC	280 mm. high	LEDC054
	407 mm. high	LEDC054L
	280 mm. w/. rockguard	LEDC054P
	407 mm. w/. rockguard	LEDC054LP
LEDD	n/a	LEDD054
	drain conn.	LEDD054D
LEDS	n/a	LEDS054

### CHOOSE CABLE

Cable For...	Cable Length	Part No.
White LED	3 m.	ELCORD005M03
	6 m.	ELCORD005M06
White LED Dimmable	3 m.	ELCORD160M03
	6 m.	ELCORD160M06

### CHOOSE ADDITIONAL OPTIONS

OPTIONS	PART NUMBER
Flood Optics	Contact Crystal for details

### EXAMPLE OF HOW TO ORDER

Quantity	Product	Part No.
1	Light with Niche	LEDD054
1	6 m. DMX Dimmable Cable	ELCORD160M06

#### WHITE LED Light

Photometry Test is done in accordance with IES no. LM-35-1989 & LM-79-08

#### CANDLEPOWER TRACE THROUGH ORIGIN

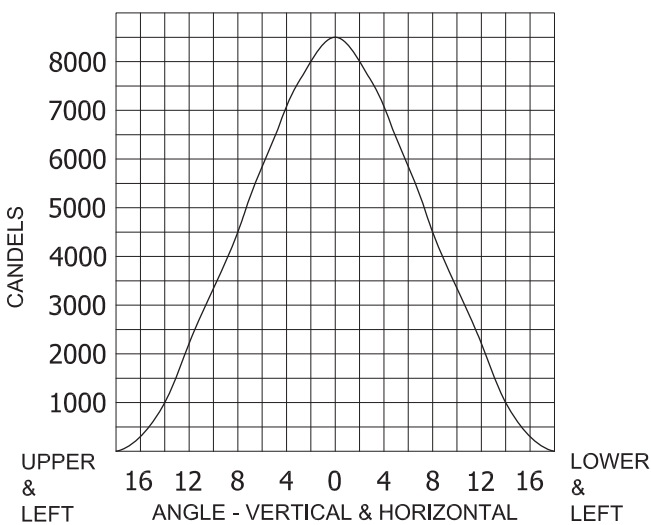

#### ILLUMINANCE DISTRIBUTION (FC/LUX)

DISTANCE ABOVE FT/M	0'/0m	1'/0.33m	2'/0.67m	3'/1.0m
6'/2.00m	233 / 98.2	7 / 880	2 / 68.5	2097 / 17.9
5'/1.67m	336 / 92.8	4.6 / 832	2.5 / 41.5	3010 / 22.5
4'/1.33m	525 / 60.1	4.5 / 534	2.1 / 40.5	4750 / 18.5
3'/1.00m	936 / 27.8	5.5 / 247	0.9 / 49.4	8414 / 8.4
2'/0.67m	2113 / 18	2.1 / 160	0.5 / 19.1	18795 / 4.1
1'/0.33m	8537 / 8.3	0.6 / 72.9	0.1 / 4.9	78142 / 0.8

## LED055 Series – 12VDC/30W LED White Light - Wet and Dry

General purpose 12VDC underwater, wet and dry location light fixture with white LED technology. Lots of flexibility to suit your application - available in 4 different mounting styles from freestanding to niche mounted. Also available in 2 different cable lengths and spot or flood lamp. Best used to light no higher than 6m. Powered using standard 12V power supply. CE Marking and cULus listed to safety standards for use in traditional basin style fountains. (Not for swimming pool and spas). Cable to be ordered separately and pre-installed. With the use of an external DMX controller and proper cable option, lights can be dimmed or turned on/off individually to create animated light sequences. Made of cast bronze, copper with stainless steel fasteners.

**Not all LEDs are created equally! Crystal Fountains LED products produce a high intensity light and deliver perfect optical performance. Also, see Crystal Fountains power/data and controller products to create a complete LED system.**

*\*Contact Crystal Fountains for detailed specifications, installation and operation details.*



<p>LED B055 - Light with T-Foot</p>	<p>LED C055 - Freestanding Light</p>	<p>LED D055 - Light with Niche</p>	<p>LED S055 - Light with Slab Hanger</p>

### DIMENSIONS

Part No.	a dim. (mm)	b dim. (mm)	c dim. (mm)
LEDB055	127	261	
LEDC055	280 to 407	280	248
LEDD055	229	331	
LEDS055	115	331	26



# LED055 Series – 12VDC/30W LED White Light - Wet and Dry

## How to Order

### CHOOSE LIGHT

Light Fixture	Part No.
Series Options	
LEDB n/a	LEDB055
rockguard	LEDB055P
LEDC 280 mm. high	LEDC055
407 mm. high	LEDC055L
280 mm. w/. rockguard	LEDC055P
407 mm. w/. rockguard	LEDC055LP
LEDD n/a	LEDD055
drain conn.	LEDD055D
LEDS n/a	LEDS055

### CHOOSE CABLE

Cable For...	Cable Length	Part No.
White LED	3 m.	ELCORD005M03
	6 m.	ELCORD005M06
White LED Dimmable	3 m.	ELCORD160M03
	6 m.	ELCORD160M06

### EXAMPLE OF HOW TO ORDER

Quantity	Product	Part No.
1	Light with Niche	LEDD055
1	6 m. DMX Dimmable Cable	ELCORD160M06
6	Flood Optics	LED160C006F

### CHOOSE ADDITIONAL OPTIONS

OPTIONS	PART NUMBER
Flood Optics	contact Crystal for details

#### WHITE LED Light

Photometry Test is done in accordance with IES no. LM-35-1989

CANDLEPOWER TRACE THROUGH ORIGIN

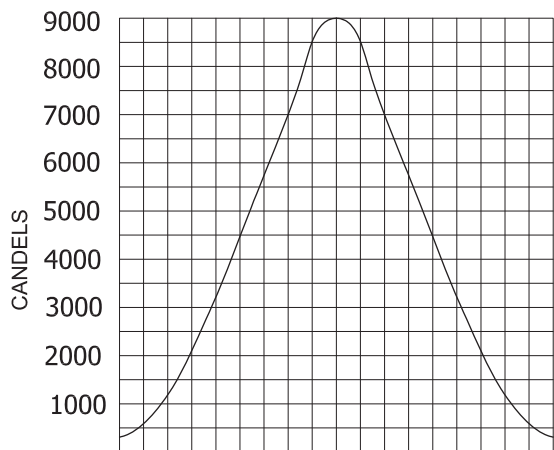

UPPER & LEFT 16 12 8 4 0 4 8 12 16 LOWER & LEFT

ILLUMINANCE DISTRIBUTION (FC/LUX)

DISTANCE ABOVE FT/M	0'0m	1'0.33m	2'0.67m	3'1.0m
6'2.00m	253	107	9.1	3.2
	2282	961	81.6	19.9
5'1.67m	365	102	5.7	2.6
	3275	922	51.9	23
4'1.33m	571	72.2	5	1.9
	5167	642	44.9	17.4
3'1.00m	1018	36.2	5.4	0.6
	9153	322	48.9	5.2
2'0.67m	2299	20	1.3	0
	20442	178	11.9	0
1'0.33m	9289	5	0	0
	84956	42.2	0	0

0'0m 1'0.33m 2'0.67m 3'1.0m DISTANCE FROM CENTER (FT/M)

## LEDo60 Series – 24VDC/60W LED Color Changing and White Light - Wet and Dry

The LEDo60 Series 24V LED light is a general purpose combination pure white and RGB color-changing LED light. A total of 60 watts of power is available by combining the 30 watts of white and 30 watts of RGB to produce powerful illumination capabilities. This general-purpose underwater light is suitable for wet locations and provides good wall washing or up-lighting. The light works in a systems approach with many generic power supplies and I-player/DMX controllers\*. The LEDo60 Series light output is clear and bright at 6500 Kelvin. Available in 4 different mounting options from free standing to slab hanger. Also available with lens guards and 2 cable lengths. cETLus and IP68 listed. Made of cast bronze.

**Not all LEDs are created equally! Crystal Fountains LED products produce a high intensity light and deliver perfect optical performance. Also, see Crystal Fountains power/data and controller products to create a complete LED system.**

*\*Contact Crystal Fountains for detailed specifications, installation and operation details.*

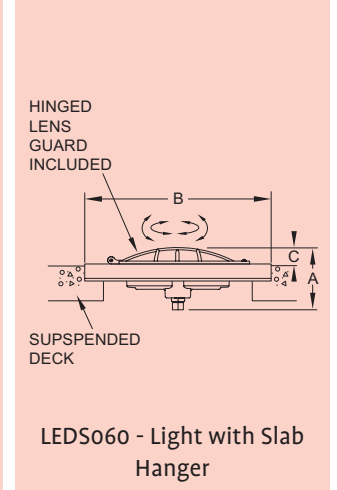
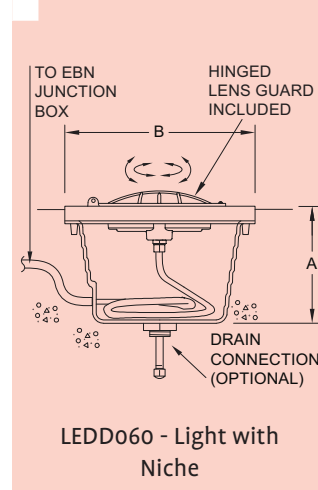
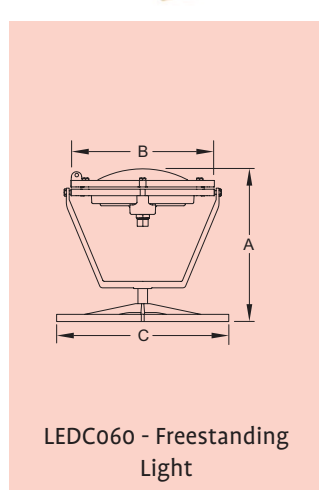
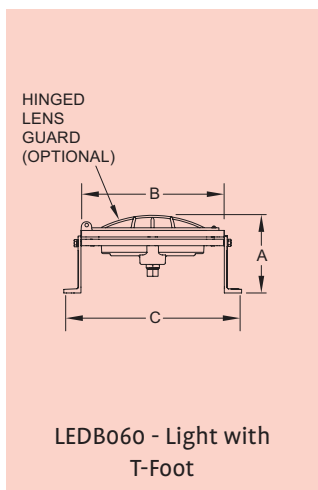
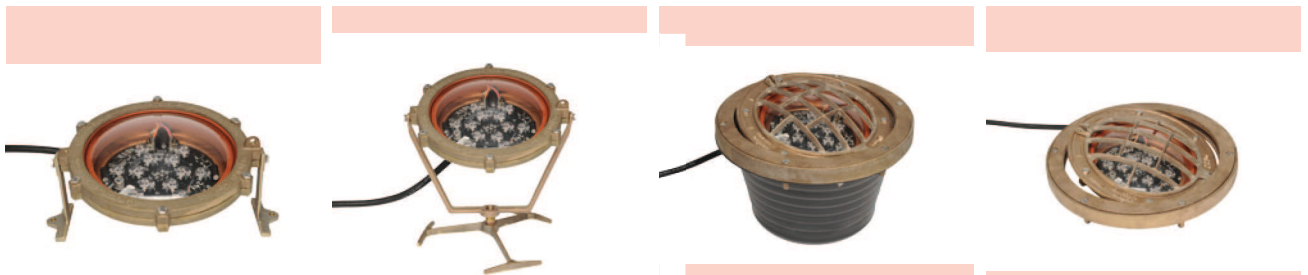

# LEDo60 Series – 24VDC/60W LED Color Changing and White Light - Wet and Dry

## DIMENSIONS

Part No.	a dim. (mm)	b dim. (mm)	c dim. (mm)
LEDBo60	127	261	305
LEDCo60	280 to 407	280	248
LEDDo60	229	331	
LEDSo60	115	331	26

## How to Order

### CHOOSE LIGHT

Light Fixture	Options	Part No.
Series		
LEDB	n/a	LEDBo60
	rockguard	LEDBo60P
LEDC	280 mm. high	LEDCo60
	407 mm. high	LEDCo60L
	280 mm. w./ rock-guard	LEDCo60P
	407 mm. w./ rock-guard	LEDCo60LP
LEDD	n/a	LEDDo60
	drain conn.	LEDDo60D
LEDS	n/a	LEDSo60

### CHOOSE CABLE

Cable Length	Part No.
3 m.	EL CORDo60Mo3
6 m.	EL CORDo60Mo6

### CHOOSE ADDITIONAL OPTIONS

OPTIONS	PART NUMBER
Flood Optics	Contact Crystal for details

### EXAMPLE OF HOW TO ORDER

Quantity	Product	Part No.
1	Light with Niche	LEDDo60
1	6 m. DMX Dimmable Cable	ELCORDo60Mo6

## RGBW LED Light

Photometry Test is done in accordance with IES no. LM-35-1989

CANDLEPOWER TRACE THROUGH ORIGIN

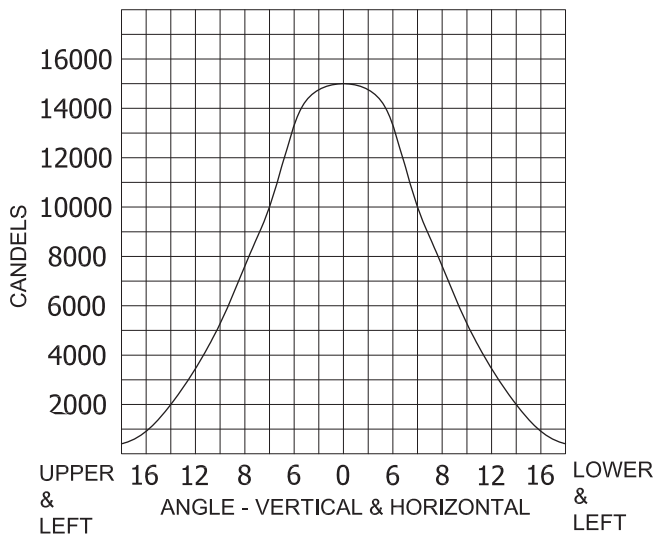

DISTANCE ABOVE FT/M

ILLUMINANCE DISTRIBUTION (FC/LUX)

6'/2.00m	445 3974	174 1559	12.3 111	4.9 44.1
5'/1.67m	655 5808	157 1481	9.1 82.2	6.1 54.7
4'/1.33m	1057 9434	95 855	12.6 103	4.4 39.7
3'/1.00m	1986 17526	43.6 395	21.1 110	2.3 21.3
2'/0.67m	5011 43192	52.1 456	4.8 44.4	1.3 12.4
1'/0.33m	29559 253391	15.4 139	0.9 9	0.1 0.7
			0'/0m	1'/0.33m
			2'/0.67m	3'/1.0m
			DISTANCE FROM CENTER (FT/M)	



# LED160 Series – 12V/30W RGB or White LED Ring Light - Wet and Dry

The LED160 series 12V LED light is one of our series of circular LED lights. With a center hole of 58mm diameter you can accommodate many Crystal Fountains nozzles and light the water 360°! This general-purpose underwater light is suitable for wet or dry locations and provides good wall washing or up-lighting. RGB works in a systems approach with many generic power supplies and I-player/DMX controllers\*. (See LED Accessories on pg 161). White light powered using standard 12V power supply. The LED 160 Series light output is clear and bright. Available with multiple mounting options: T-Foot stand, foot-friendly (flush-mounted), niched to slab hanger. Also available in spot or flood lamps and a variety of cable lengths. With the use of an external DMX controller and proper cable option, lights can be dimmed or turned on/off individually to create animated light sequences. Made of 316 stainless steel.

**Not all LEDs are created equally! Crystal Fountains LED products produce a high intensity light and deliver perfect optical performance. Also, see Crystal Fountains power/data and controller products to create a complete LED system.**

*\*Contact Crystal Fountains for detailed specifications, installation and operation details.*

## Which Ring Light Do I Need?

1.Choose Your Application	Slab Hanger Light with Hole for Jet		Foot Friendly Light Niche		Light with Stand		Foot Friendly Slab Hanger Light Only		Flush Mounted Slab Hanger Light with Hole for Jet	
	White LED	RGB LED	White LED	RGB LED	White LED	RGB LED	White LED	RGB LED	White LED	RGB LED
3.Get Part Number	LED 160003	LED 160004	LED 160005	LED 160006	LED 160007	LED 160008	LED 160009	LED 160010	LED 160011	LED 160012

LED160003/160004    LED160005/160006    LED160007/160008    LED160009/160010    LED160011/160012

Technical diagrams showing dimensions (A, B, C, D, E) and installation details for various models:

- LED160003/160004:** Slab hanger light with hole for jet, showing connection to EBN Junction Box and optional drain connection.
- LED160005/160006:** Foot friendly light niche, showing connection to EBN Junction Box and optional drain connection.
- LED160007/160008:** Light with stand, showing connection to EBN Junction Box.
- LED160009/160010:** Foot friendly slab hanger light only, showing connection to EBN Junction Box.
- LED160011/160012:** Flush mounted slab hanger light with hole for jet, showing connection to EBN Junction Box and nozzle not included.

## LED160 Series – 12V/30W RGB or White LED Ring Light - Wet and Dry

LED LIGHTING TECHNOLOGY



### DIMENSIONS

Part No.	a dim. (mm)	b dim. (mm)	c dim. (mm)	d dim. (mm)
LED160003	77	204	185	10
LED160004	77	204	185	10
LED160005	180	235		
LED160006	180	235		
LED160007	153	204	153	10
LED160008	153	204	153	10
LED160009	77	204	185	10
LED160010	77	204	185	10
LED160011	77	204	185	10
LED160012	77	204	185	10

### How to Order

#### CHOOSE LIGHT

Lighting	Mounting	Lamp	Part No.
White	Slab Hanger Light with Hole	Spot	LED160003
	Foot Friendly Niche Light	Spot	LED160005
	Light with Stand	Spot	LED160007
	Foot Friendly Slab Hanger Light Only	Spot	LED160009
	Flush Mounted Slab hanger Light With Hole	Spot	LED160011
RGB	Light with Slab Hanger	Spot	LED160004
	Foot Friendly Niche Light	Spot	LED160006
	Light with Stand	Spot	LED160008
	Foot Friendly Slab Hanger	Spot	LED160010
	Flush Mounted Slab Hanger Light With Hole	Spot	LED160012

# LED160 Series – 12V/30W RGB or White LED Ring Light - Wet and Dry

### CHOOSE CABLE

Cable For...	Cable Length	Part No.
White LED	3 m.	ELCORD005M03
	6 m.	ELCORD005M06
White LED DMX Dimmable	3 m.	ELCORD160M03
	6 m.	ELCORD160M06
RGB LED	3 m.	ELCORD160M03
	6 m.	ELCORD160M06

### EXAMPLE OF HOW TO ORDER

Quantity	Product	Part No.
1	RGB LED Slab Hanger Light	LED160004
1	3 m. RGB Cable	ELCORD160M03
6	Flood Optics	LED160C006F

### CHOOSE ADDITIONAL OPTIONS

Options	Part No.
Flood Optics	LED160C006F

#### RGB LED Light

Photometry Test is done in accordance with IES no. LM-35-1989

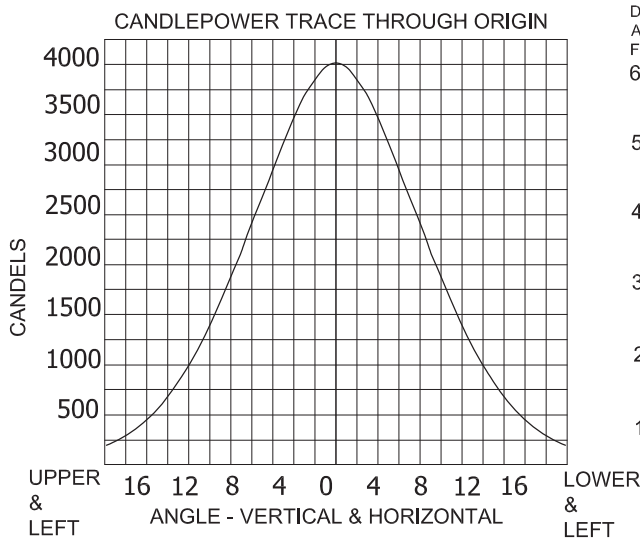

**ILLUMINANCE DISTRIBUTION (FC/LUX)**

DISTANCE ABOVE FT/M	0'/0m	1'/0.33m	2'/0.67m	3'/1.0m
6'/2.00m	112	43.8	5.0	1.2
5'/1.67m	1012	392	45.3	10.5
4'/1.33m	1453	392	28.9	12.0
3'/1.00m	253	36.0	2.6	1.2
2'/0.67m	2293	320	23.7	10.4
1'/0.33m	451	20.1	3.1	2.3.6
	4061	179	27.5	5.3
	1020	10.6	1.3	0.3
	9072	94.5	11.9	2.7
	4122	5.2	0.4	0.1
	37711	46.1	3.3	0.8

DISTANCE FROM CENTER (FT/M)

#### WHITE LED Light

Photometry Test is done in accordance with IES no. LM-35-1989

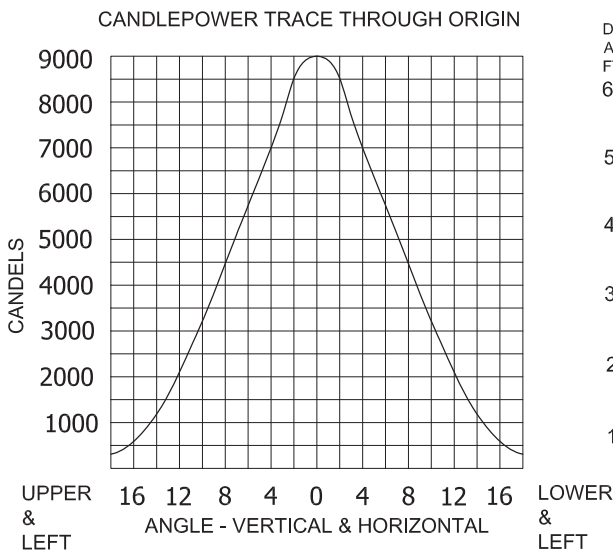

**ILLUMINANCE DISTRIBUTION (FC/LUX)**

DISTANCE ABOVE FT/M	0'/0m	1'/0.33m	2'/0.67m	3'/1.0m
6'/2.00m	253	107	9.1	3.2
5'/1.67m	2282	961	81.6	19.9
4'/1.33m	365	102	5.7	2.6
3'/1.00m	3275	922	51.9	23
2'/0.67m	571	72.2	5	1.9
1'/0.33m	5167	642	44.9	17.4
	1018	36.2	5.4	0.6
	9153	322	48.9	5.2
	2299	20	1.3	0
	20442	178	11.9	0
	9289	5	0	0
	84956	42.2	0	0

DISTANCE FROM CENTER (FT/M)

# LED190 Series – 12V/30W Nighed RGB or White LED Playdeck Light

The LED190 Series 12V LED light is perfect for any playdeck water feature. Its pedestrian-friendly clear acrylic faceplate provides a dramatic up-light to many water features and is a perfect companion to Crystal Fountains Dynamite Blast™ nozzle. RGB works in a systems approach with many generic power supplies and I-player/DMX controllers\*. (See LED Accessories on pg 161). White light powered using standard 12V power supply. Good for wet or dry locations and internally adjustable by up to 20° for different applications. The LED 190 Series light output is clear and bright. Made of stainless steel, copper, bronze and acrylic.

**Not all LEDs are created equally! Crystal Fountains LED products produce a high intensity light and deliver perfect optical performance. Also, see Crystal Fountains power/data and controller products to create a complete LED system.**

*\*Contact Crystal Fountains for detailed specifications, installation and operation details.*



## Which Foot-Friendly Dry Deck Light Niche Do I Need?

1. Choose Your Lighting Effect	White LED	RGB LED
2. Get Part Number	LED190001	LED190002

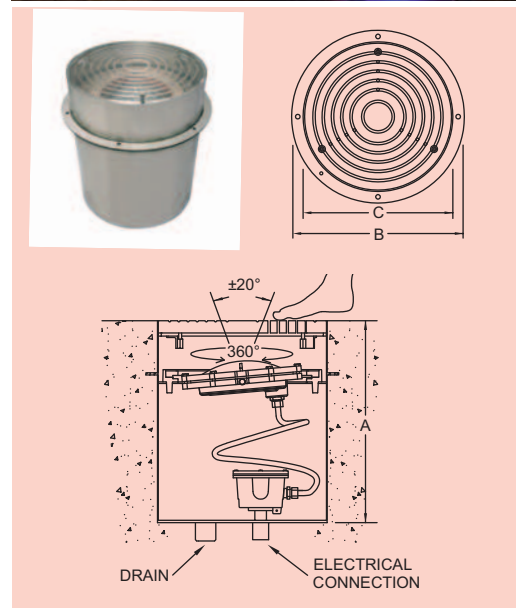

### DIMENSIONS

Part No.	a dim. (mm)	b dim. (mm)	c dim. (mm)
LED190001	458	401	350
LED190002	458	401	350

## How to Order

### Choose Additional Options

Options	Part No.
Flood Optics	LED160C006F

### CHOOSE LIGHT

Lighting	Lamp	Part No.
White LED	Spot	LED190001
RGB LED	Spot	LED190002

